

BETENBENDER

Manufacturing, Inc.

AMERICAN MADE WITH PRIDE & DURABILITY

Press Brakes · Shears · C Frame Presses



*The Betenbender Family of American Made
Hydraulic Shears and Press Brakes
Since 1972*

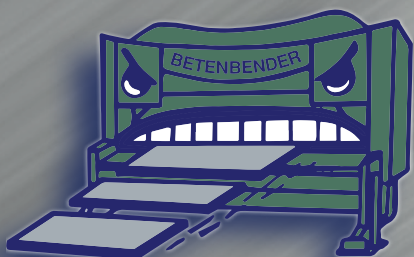

Located in Coggon, Iowa

Also on the Web at
www.betenbender.com

HMI
Hydraulic Machines of Iowa

INDEX

WELCOME	1
ABOUT US.....	2-3
SHEARS.....	4-11
Standard Features.....	5
Options.....	6-7
Specifications.....	8-11
BACKGUGAGES.....	12-13
Shears.....	12
Press Brakes.....	13
PRESS BRAKES.....	14-23
Standard Features.....	15
Options.....	16-17
Features Information.....	18
Tonnage Chart.....	19
Specifications.....	20-23
HMI.....	24-27
Tonnage Chart.....	25
Standard Features And Options.....	26
Specifications.....	27
OTHER INFO.....	28-29
Serial Number & Oil.....	28



BETENBENDER MANUFACTURING, INC.

5806 Quality Ridge Road
P.O. Box 140
Coggon, Iowa 52218

Office: 319-435-2378

Fax: 319-435-2262



www.betenbender.com
sales@betenbender.com

Shears

Press Brakes

C Frame Presses

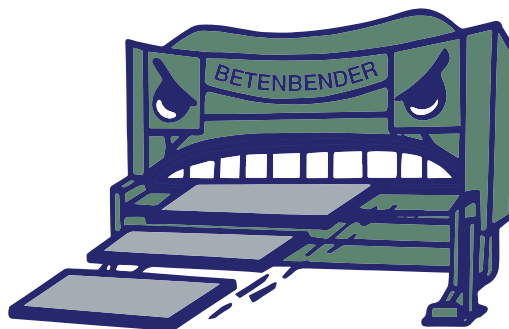

If you're not already a customer of Betenbender Manufacturing, Inc. we welcome you as a future owner of an American made Betenbender Hydraulic Shear, Hydraulic Press Brake or C Frame Press. If you've purchased one before, we welcome you back. We are pleased that our customers come back again and again, as they grow and need more equipment.

Our full range of Hydraulic machines are engineered for simplicity and ease of operation. We have a national and international sales and service team ready to serve you.

Since 1972 we have continually updated our designs and equipment to meet our customers' needs. We always appreciate and welcome feedback from our customers.

Max Betenbender

-Max Betenbender, President

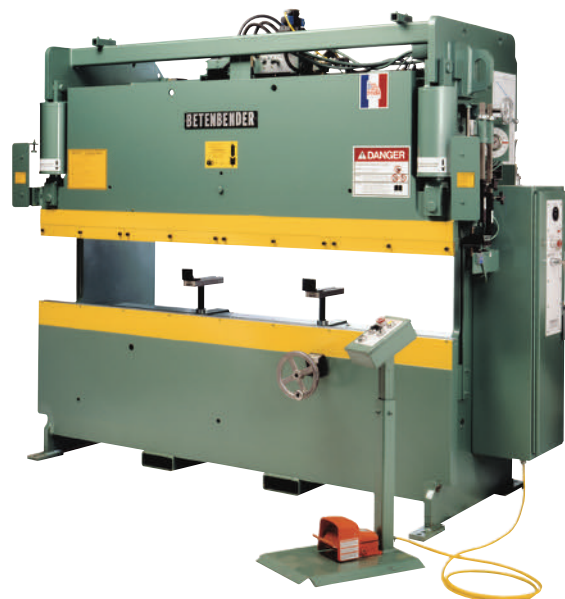

ABOUT US



1971



2014

Family Tradition and American Pride

ABOUT US

Our History

The Betenbender Family of American Hydraulic Shears and Hydraulic Press Brakes is made by Betenbender Manufacturing, Inc. in Coggon, Iowa, U.S.A. Now in our fifth decade in business, our Midwestern Company continues to produce what we believe is America's best built Shears and Press Brakes.

Glen (Pete) Betenbender began as a blacksmith in Coggon during the 1930s. During WWII, he ran a small fabrication and repair shop. In 1948 he and his wife, Blanche, moved their growing business into their current location as a repair and manufacturing facility. Their son, Max, joined the company in 1967 after serving in the United States Army. In 1972, Pete and Max built their first shear for their own use, but demand from other local businesses for their shear prompted the Betenbenders to begin producing shears for national and international resale. In 1984 Betenbender Manufacturing, Inc. got its first contract to produce shears for a major company.



This Betenbender Shear, one of our first machines-built in 1972, is still in operation!

In 2012, Betenbender Manufacturing, Inc. purchased Hydraulic Machines, Inc. from long time friends, Alan and Whitney Hanner. Under the HMI (Hydraulic Machines of Iowa) name we offer a line of C frame presses ranging from 35 ton to 200 ton.

Betenbender Manufacturing, Inc. continues to be a family owned business. Today Max is President and his wife, Donna, is the corporations Secretary-Treasurer. The Vice President, Kyle Rawson, handles the operation of the manufacturing facility which includes customer service and fabrication.

Today there are over 3,900 Betenbender machines in use with very few on the used market.

We have always said...



High Profile Shear - 2004

“If it says Betenbender on the nameplate, you’ve got a machine that will do the job.”

A Precision Cut Doesn't Happen By Chance

It takes a shear that can make a razor-sharp cut time after time. Betenbender overdriven and underdriven Hydraulic Shears are designed to do exactly that. Choose from a family of nine different models: 1/8" (10 GA), 3/16", 1/4", 3/8", 1/2", 5/8", 3/4", 1" and 1 1/4".

Betenbender designs simplicity and safety into its shears-with an advanced hydraulic system and flexible operation. They're easy to operate, easy to maintain and able to withstand the rigors of today's production demands. A wide range of options are available -- See pages 6 & 7

Controls: Push button and switch controls are at your fingertips. The fully guarded, 2-position 110v footswitch lets you interrupt the cutting stroke at any point in its cycle.

Easy Material Handling: A sturdy backgauge and rake angle adjustment minimizes twist and distortion. This makes it possible to increase the rake for cutting heavier stock and extend maximum capacity of the machine. A 4' squaring arm with a recessed scale makes for fast, easy measurement.

Precision Cutting System: Our single piece top and bottom, high carbon, high chrome shock resistant knives provide four separate edges for clean cuts and long blade life. Easy blade gap adjustment means precise cuts for a wide variety of materials.

Electrical System: Meets NFPA 79 and construction requirements of the ANSI B11.4. All machines have disconnect switches, magnetic starters, 110/120v controls, and 208-230/460v 3 phase, others optional.

Backgauges: A Betenbender Shear is capable of shearing 1/8" (10 GA) material to the following tolerance: Dimension - The width of the off-cut portion of the workpiece is within ± 0.005 inch of the backgauge setting.



1/8" (10 GA), 3/16"



1/4"



3/8", 1/2", 5/8", 1", & 1-1/4"



There's One To Meet Your Needs

Ask your Betenbender representative how you can make precision cutting an everyday part of your manufacturing process.

STANDARD FEATURES

- 208-230/460v 3 phase
- 36" Power Backgauge with LED Readout Inch / Metric
- 4' Squaring Arm with Inlaid Scale
- All Hydraulic Fluids Included
- All Steel Construction
- American Made Hoses and Fittings
- American Made Motor and Valves
- Disconnect Switch
- Hour Meter
- Hydraulic Pressure: 2250 psi
- Hydraulic Self-Compensating Holddown Bar Assembly
- Light Beam Gauge (Shadow Line)
- Linemaster Foot Switch
- Manual Rapid Blade Gap Adjustment (3/8" and Larger)
- Manual Swingup Backgauge
- NEMA Electrics
- Power Adjust Variable Rake
- Safety Switch for Front Guard
- Single Piece Top and Bottom, Shock Resistant Knives with Four Cutting Edges

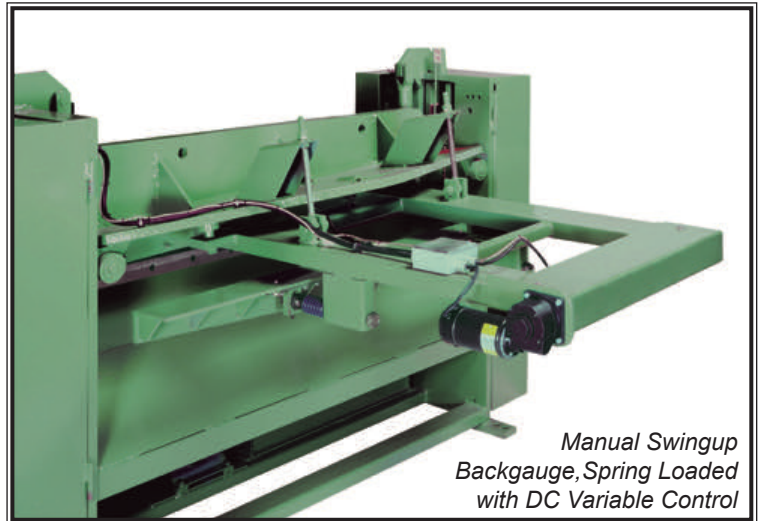

Manual Swingup Backgauge, Spring Loaded with DC Variable Control

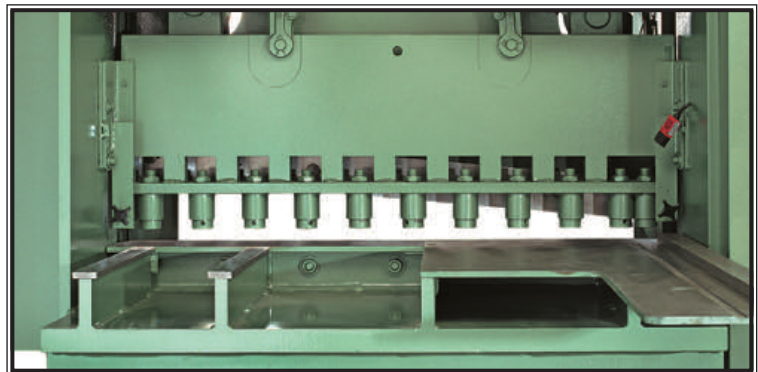

Hydraulic Self-Compensating Holddown Bar Assembly

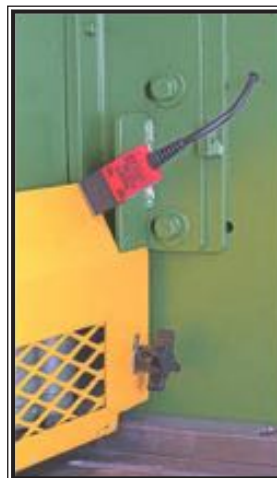

Safety Switch for Front Guard



Control Panel w/ 5 Station NC "GO-TO" Backgauge Positioner (emergency up, rake control, shear palm button standard)



Linemaster Footswitch

Take Betenbender's High Quality Shear & Add Shear Options To "Build It Your Way!"

OPTIONS

- 5 Station NC "GO-TO" Positioner
- **48" Support Arms/Front Gauges**
- Inlaid Scale (0-48")
- Disappearing Stops (Support Arms)
- **Solid Table Top - Bolt on Segments**
- Machined Solid Table Top Bed
- **Neoprene Holddown Caps**
- **One Shot Lubrication**
- Automatic Lubrication
- Oil Cooler
- Ball Transfers
- Angle Gauge
- Electronic Stroke Control
- Continuous Stroke (Includes Stroke Counter)
- Stroke Counter
- Independent Holddown Control
- Extra Foot Pedal with Keylock Switch
- Extended Squaring Arm (4' Standard)
- Flip Up Stops (Squaring Arm)
- Left Hand Squaring Arm (4')
- Dovetail Slots or T-Slots
- Keylock Switch
- 2 Position Power Blade Gap Adjustment (3/8" and Larger)
- **3 Position Power Blade Gap Adjustment (3/8" and Larger)**
- Pneumatic Sheet Support
- 208v Single Phase
- Special Paint Colors
- Other Electrics and Motors
- Bolt/Shim Kit for Leveling
- Harder Grade of High Carbon, High Chrome Knives
- CSA
- Phenolic Tabletop

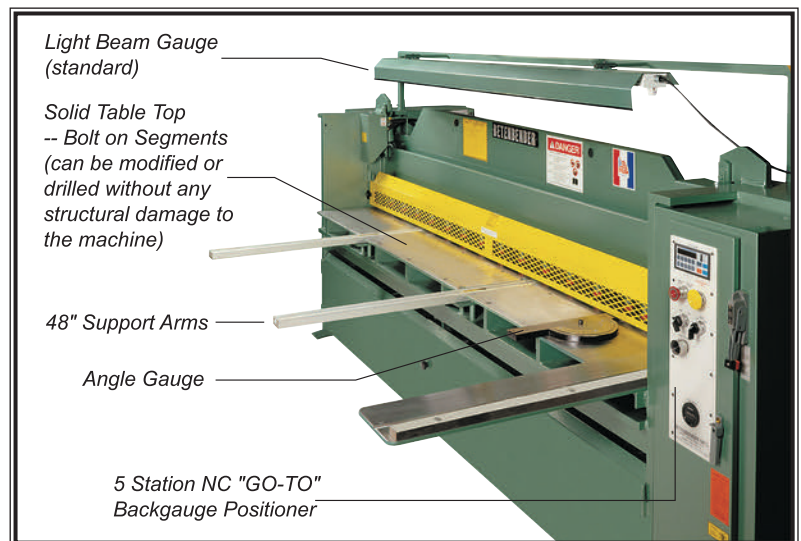
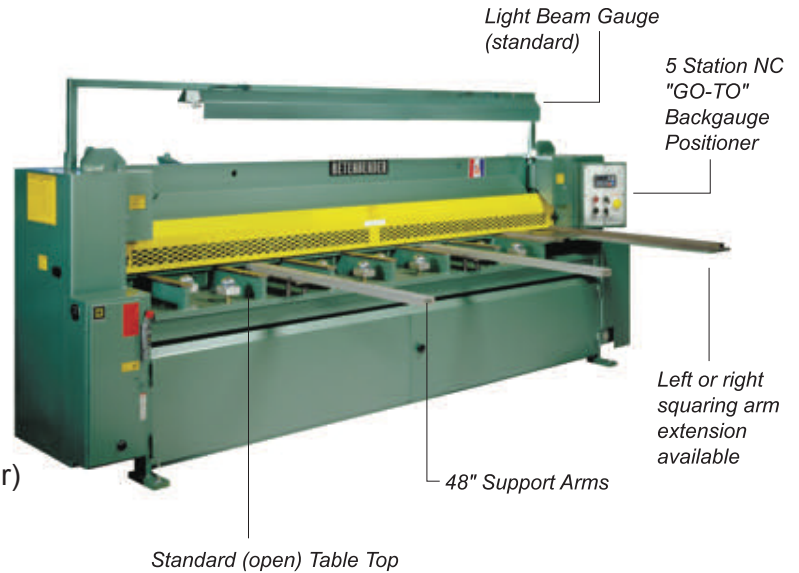

BACKGAUGES

- Manual Swing Up Backgauge (Standard)
- Power Lift
- **Automatic Power Lift**
- Extra Length on Backgauge

ASK ABOUT OPTIONS NOT LISTED
RECOMMENDED OPTIONS FOR ALL MACHINES

ADDITIONAL RECOMMENDED OPTIONS FOR 3/8", 1/2", 5/8" & 3/4" MACHINES



Betenbender's Options Help Optimize Your Production Needs

OPTIONS



Segmented Table Top with Angle Gauge, Front Support Arms, Ball Transfers, Disappearing Stop and Inlaid Scale.

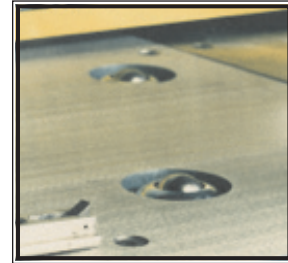

Ball Transfers

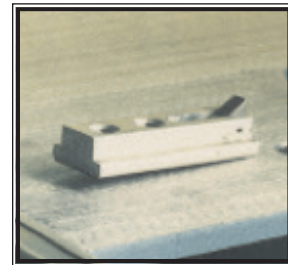

Disappearing Stop

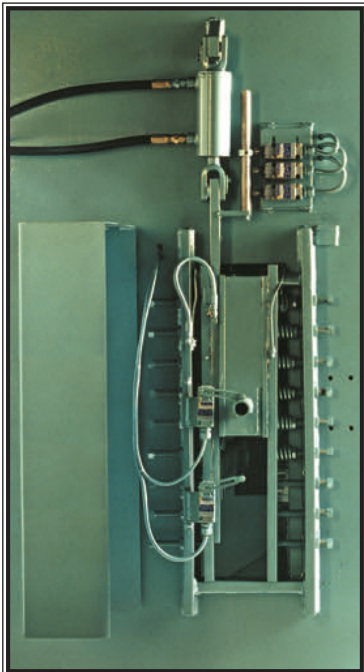

3-Position Power Rapid Blade Gap Adjustment



Control Panel with Hour Meter, Stroke Control, 3-Position Power Rapid Blade Gap with Indicator Lights (power backgauge standard, shear palm button standard) Indicator Lights Show Position of Blade Gap

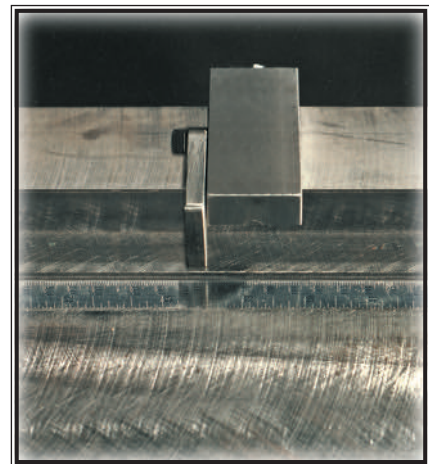

Flip Up Stop



SHEAR SPECIFICATIONS

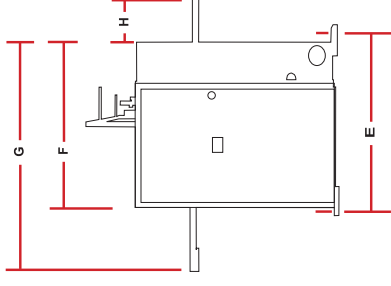
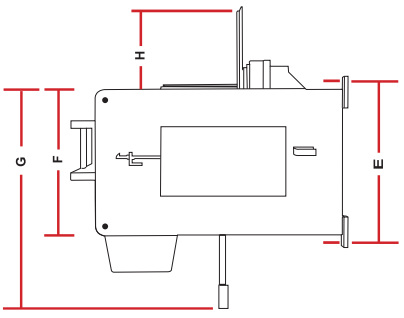
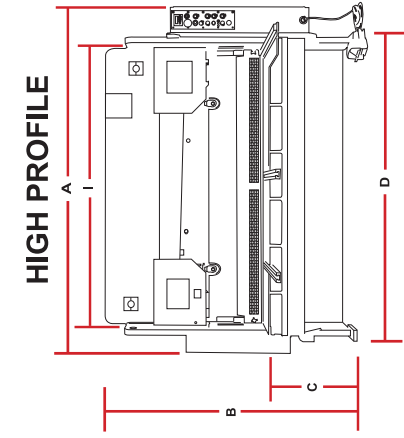

All dimensions are in inches unless otherwise noted.
(To convert to centimeters multiply by 2.54)

Engineering data and dimensions are subject to change without notice due to continuing product development.

Foundation plans are available upon request.

10 GA, 3/16", and 1/4", machines will be low profile, unless it is a gap type machine.

*Larger motor sizes are available. To convert from horsepower to KW, multiply by 0.746

**ESTIMATED WEIGHTS. The weight of your machine may vary from the estimated weight listed here. Weights may vary according to options included.

***1 x 12" has separate power unit.

Please Note: ALL measurements may and weights may vary from the figures given in this Specification Chart.

HP	208/230	460
5	14	7
10	28	14
15	39.6	19.3
20	52	26
25	68	34
30	80	40
40	104	52

A	Overall Length	D	Anchor Bolt Dimension/Length	G	Machine w/ Backgauge	J	Rake Angle per Rated Capacity
B	Overall Height	E	Anchor Bolt Dimension/Width	H	Squaring Arm Length (4' Std.)	K	Strokes Per Minute
C	Table Height	F	End Plate Width	I	Knife Length	L	Number of Holddown Pins

MODEL	KNIVES	H.P.*	A	B	C	D	E	F	G	H	I	J	K	L	Wt.**
2'-125	½ x 2	10	48	55	32	33	36	30	74	30	28	1/4	35	6	3,400
4'-125	1x3	10	75	55	32	52	36	30	74	30	52	1/4	35	13	4,500
5'-125	½ x 2	10	85	55	32	64	36	30	74	30	62	1/4	35	11	4,800
6'-125	1x3	10	97	55	32	76	36	30	74	30	76	1/4	35	13	6,500
8'-125	1x3	10	121	55	32	100	36	30	74	30	100	1/4	32	15	6,800
10'-125	1x3	10	145	55	32	124	36	30	74	30	124	1/4	30	19	9,100
12'-125	1x3	10	169	60	32	148	36	30	74	30	148	1/4	26	21	14,000
14'-125	1x3	10	193	60	32	172	36	30	74	30	172	1/4	24	23	18,000
16'-125	1x3	10	217	60	32	196	36	30	74	30	196	1/4	22	25	20,000
2'-1875*	½ x 2	10	48	64	32	40	36	30	74	30	28	1/4	35	6	3,500
4'-1875	1x3	10	75	55	32	52	36	30	74	30	52	1/4	35	13	4,500
5'-1875	½ x 2	10	85	55	32	64	36	30	74	30	62	1/4	35	11	4,800
6'-1875	1x3	10	97	55	32	76	36	30	74	30	76	1/4	35	13	6,700
8'-1875	1x3	10	121	55	32	100	36	30	74	30	100	1/4	32	15	7,000
10'-1875	1x3	10	145	55	32	124	36	30	74	30	124	1/4	30	19	9,100
12'-1875	1x3	10	169	60	32	148	36	30	74	30	148	1/4	26	21	15,000
14'-1875	1x3	10	193	60	32	172	36	30	74	30	172	1/4	24	23	19,000
16'-1875	1x3	10	217	60	32	196	36	30	74	30	196	1/4	23	25	20,500
4'-250	1x4	15	84	61	32	55	50 ½	44	76	35	52	1/4	20	13	7,500
6'-250	1x4	15	108	61	32	79	50 ½	44	76	35	76	1/4	19	13	8,400
8'-250	1x4	15	132	61	32	103	50 ½	44	76	35	100	1/4	17	15	9,800
10'-250	1x4	15	156	61	32	127	50 ½	44	76	35	124	1/4	15	19	12,500
12'-250	1x4	15	180	61	32	151	50 ½	44	76	35	148	1/4	13	21	14,000
14'-250	1x4	15	204	61	32	175	50 ½	44	76	35	172	1/4	11	23	20,000
16'-250	1x4	15	228	61	32	199	50 ½	44	76	35	196	1/4	10	25	22,000
2'-375*	½ x 2	15	48	64	38	40	35	34	80	10	28	1/4	12	6	4,400
4'-375	1x4	20	75 ½	84	32	56	55	48	80	24	52	3/8	17	11	11,000
6'-375	1x4	20	99 ½	84	32	80	55	48	80	24	76	3/8	17	14	15,100
8'-375	1x4	20	123 ½	84	32	104	55	48	80	24	100	3/8	13	14	18,500
10'-375	1x4	20	147 ½	84	32	128	55	48	80	24	124	3/8	11	17	21,000
12'-375	1x4	20	171 ½	84	32	152	55	48	80	24	148	3/8	10	20	24,000
14'-375	1x4	20	195 ½	84	32	176	55	48	80	24	172	3/8	9	23	27,000
4'-500	1x4	20	75 ½	84	32	56	55	48	80	24	52	1/2	13	11	13,800
6'-500	1x4	20	99 ½	84	32	80	55	48	80	24	76	1/2	13	14	17,000
8'-500	1x4	20	123 ½	84	32	104	55	48	80	24	100	1/2	10	14	22,500
10'-500	1x4	20	147 ½	84	32	128	55	48	80	24	124	1/2	9	17	28,000
12'-500	1x4	20	171 ½	84	32	152	55	48	80	24	148	1/2	8	20	32,000
10'-625	1x4	30	147 ½	84	32	128	55	48	80	24	124	1/2	9	17	28,000
12'-625	1x4	30	171 ½	84	32	152	55	48	80	24	148	1/2	8	20	32,000
4'-750	1 1/8x5	40	77	97	32	56	55	48	80	32	52	5/8	11	11	15,700
6'-750	1 1/8x5	40	101	97	32	80	55	48	80	32	76	5/8	10	14	22,000
8'-750	1 1/8x5	40	125	97	32	104	55	48	80	32	100	5/8	8	14	27,000
10'-750	1 1/8x5	40	149	97	32	128	55	48	80	32	124	5/8	7	17	31,000
12'-750	1 1/8x5	40	173	97	32	152	55	48	80	32	148	5/8	6	20	35,000
1"-12"	1/4	20	48	64	38	128	55	36	80***	12	18	1/4	12	8	TBA



TECHNICAL SPECIFICATIONS

Frame and Base: Side frames are welded to the table base assembly as a closed end type, which is standard. With the gap end option, base of end housings have provisions to anchor machines to flat surface. The upper knife is manufactured with means of adjustment for obtaining and maintaining clearance adjustment between upper and lower knives. Mounting holes in the feet allow for firm attachment to the floor and leveling of the machine.

Table: The table is constructed of fabricated steel, which is flat to ± 0.005 inch per linear foot. The standard table is solid for the first 24 inches on the right side with support beams 16 inches on center for balance of machine.

Options:

1. Solid table top bolt on segments
2. Machined bed
3. Hand slots (optional where specified)
4. Ball transfers (available in any of the table top patterns - open, bolt on segments or machined solid table top)

Ram: The ram is guided through the shearing stroke by a bronze slide assembly and a steel assembly. The assemblies guide the ram on a vertical shearing plane with 2 angular degrees off the shearing plane of the stationary knife. The bronze slides have a large surface area to dissipate pressure per square inch. The PSI is low in comparison to machines that use swings or have many pins and little area to dissipate the pressure. Optional non-metallic slide assemblies are available to replace bronze.

Hydraulic System: The hydraulic system is designed for the capacity of the rated machine to JIC standards. The hydraulic system has safety overload protection. Hoses, tubes and fittings are rated at no less than 150% of the rated working pressure.

Hydraulic Cylinder Drive: There are two direct acting hydraulic cylinders for directing the ram. The hydraulic cylinder drive has double acting pistons and ball sockets for self-aligning joints.

Hydraulic Hold down System: On the 1/8" (10 GA), 3/16" and 1/4" machines the hydraulic self-compensating spring plunger bar assembly has plungers every 4 inches for the first 24 inches and plungers 8 inches on center for the remainder of the bar. On 3/8", 1/2", 5/8", 3/4", and 1" machines, the plungers are spread every 5 inches for the first 24 inches and plungers 8 1/2 inches on center for the remainder of the bar. The hydraulic holddown system automatically secures the workpiece during ram down-stroke and releases on return stroke. Optional independent holddown control is available. Refer to chart for the number of plungers.

Reservoir: The reservoir features combination level and temperature gauges and a cleanable filter system capable of removing particles 10 microns in size.

Shear Knife: Our knives are made of a shock resistant grade of modified high carbon, high chrome with four edges. Harder grade of high carbon, high chrome is available.

Controls: Controls include:

1. Pull to start, push to stop.
2. Jog (inch)- Single stroke – run
Optional: Continuous stroke
3. Single palm button for stroke
4. Backgauge controls:
 - forward/reverse
 - variable speed
5. Emergency up-switch



Rake Angle and Rake Angle Adjustment:

Power rake angle adjustment is standard. Angle is maintained throughout cutting cycle, when rake angle is adjusted to require angle. Refer to chart.

Increased adjustable rake angle is standard on all machines to allow for cutting of harder and heavier material.

Electrical System: The electrical systems meets NFPA 79 standards. All machines have disconnect switches, magnetic starters, 110/120v controls, 208-230/460v 3 phase, others optional.

Motors: Motors are open drip with sealed and permanent lubricated bearings.

Control Circuit Voltage: Control voltage is 110/120v supplied by a transformer.

Backgauge: 36" power operated backgauge is standard. Controls are located on front of the machine. 5 Station NC "GO-TO" Positioner is standard.

Front Support Arms (Optional): Front support arms are available with or without scales.

Squaring Gauge: 4' squaring arm on right-hand side with scale is standard. Left-hand squaring arm and longer gauges are optional.

Angle Gauge (Optional): Angle gauge marked in 1/2° increments.

Light Beam Gauge (Standard):

Shearing gauge utilizes light beam shadow as the shearing line.

Capacity: Machines are based on 80,000 pounds tensile. Other options are available upon request.

Convert Feet to Millimeters Multiply By 304.8	
2'	609.6 mm
4'	1219.8 mm
5'	1524.0 mm
6'	1828.8 mm
8'	2438.4 mm
10'	3048.2 mm
12'	3657.6 mm
14'	4267.2 mm

Convert Inches to Millimeters Multiply By 25.4		
1/8"	0.125	3.18 mm
3/16"	0.188	4.77 mm
1/4"	0.250	6.35 mm
3/8"	0.375	9.53 mm
1/2"	0.500	12.7 mm
5/8"	0.625	15.88 mm
3/4"	0.750	19.05 mm
1"	1.000	25.4 mm
1 1/4"	1.250	31.75 mm

Shearing Accuracy: The Betenbender Hydraulic Shears will meet or exceed shearing accuracy of material ranging up to the full width capacity of the machine to precision tolerances. The width of the sheared workpiece shall be within ±0.005 inch of the backgauge settings.

Safety Features: The Betenbender Hydraulic Shears are built to meet ANSI B11.4 standards. Some of the safety features of the Betenbender Shears are:

- Finger Guard for holddown w/ safety switch
- 110/120v control
- Guarded foot pedal
- Warning signs, safety markings & covers
- Electronics meet NFPA 79 standards
- Central systems provide the operator with complete control to stop & reverse the ram by simply releasing the control
- For multiple operators, a separate control for each person, can be provided within reach of the machine
- Emergency up-switch on control panel

Specifications are subject to change without notice.

Compliance with OSHA requirements is the legal responsibility of the user and is subject to local inspectors' interpretation of existing standards.

Betenbender Shears are built to meet ANSI B11.4 standards



BACKGAUGES FOR SHEARS

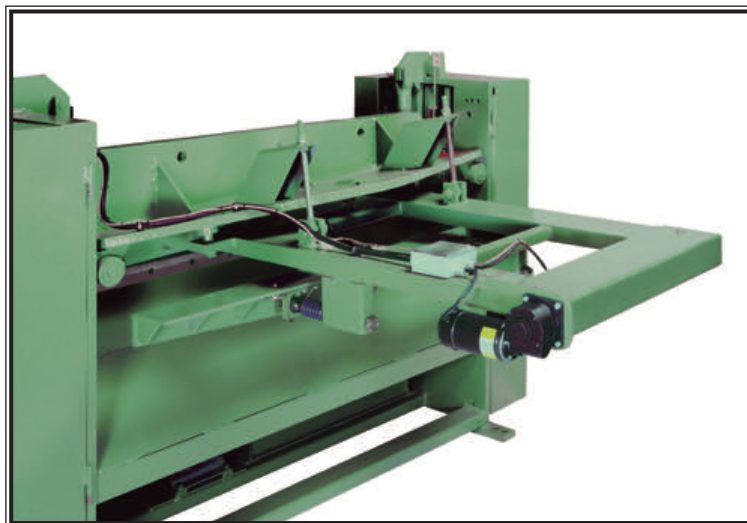

Backgauges available in
4' - 12' bar lengths.
Longer lengths...P.O.R.

Backgauges for machines
3/8" and larger... P.O.R.

#92MB

Backgauge Package:

Rear Operated Manual Backgauge, with Spring Loaded Backbar,
Mechanical Readout and Handwheel.

#92FBEL-GT

Backgauge Package:

Front Operated Electric, Front Operated Backgauge
with Single Axis 5-Station "GO-TO" Positioner and Spring Loaded Backbar
Controls located in NEMA 12 box.

#92EVL-GT

Controller Package: (For Existing Manual Operated Backgauges)

Electric, Front Operated, Single Axis 5-Station "GO-TO"
Located in NEMA 12 box

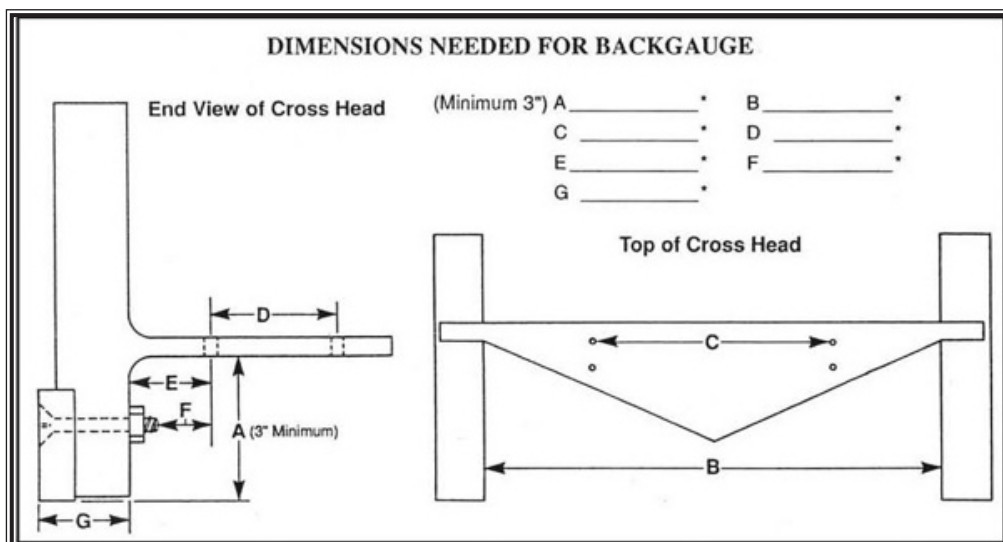

PRESS BRAKES

BACKGAUGES FOR PRESS BRAKES

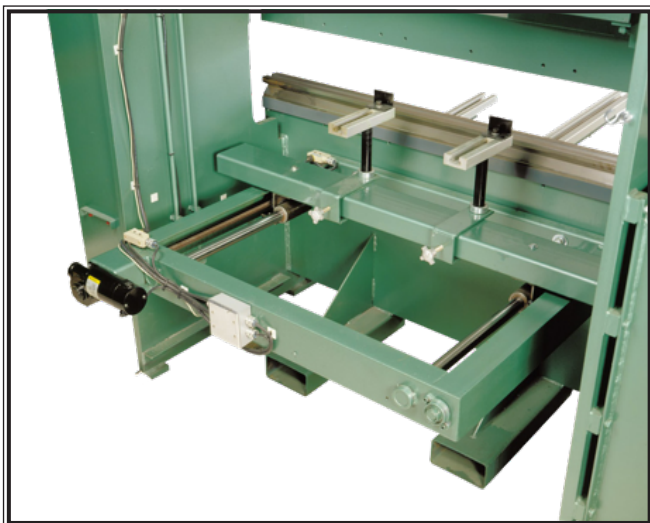

Backgauges available in
4' - 12' bar lengths.
Longer lengths...P.O.R.

#94MB24

Front Operated Manual Backgauge (24") with Mechanical Digital Readout

#94FOP24-GT

Front Operated Power Backgauge
Single Axis 5-Station "GO-TO" Positioner
Does not include swing arm pendant

#94FOP24-GT-AS

Front Operated Power Backgauge with
Auto Sequence Axis 5-Station "GO-TO" Positioner
Does not include swing arm pendant

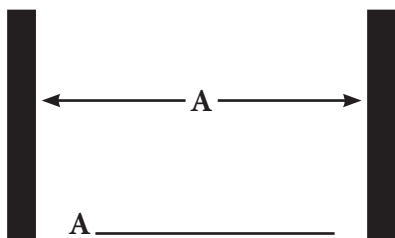

(Specify distance between
housing in inches when ordering)

**Some Modifications may be Required
to Adapt to Your Machine**

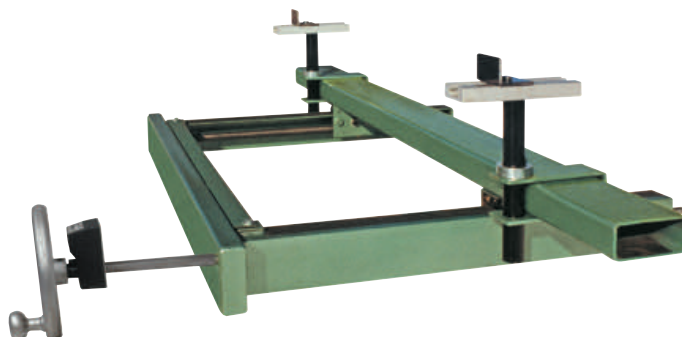

99 Station
Auto Sequence



PRESS BRAKES

If It Says Betenbender On The Nameplate, You've Got A Hydraulic Press Brake That Will Do The Job

Call 319-435-2378 to get a quote for your Betenbender Hydraulic Press Brake... Be ready with the answers to these questions...

1. Do you have a press brake tooling catalog?
2. What is the longest and heaviest material you will be bending? What type of material will you be forming? (mild, stainless, etc.)
3. What is the distance needed between uprights?
4. Do you require the following recommended options:
 - a. Front support arms
 - b. Front operated manual backgauge
 - c. One shot lubrication (for shops without regular maintenance)
 - d. Keylock switch
 - e. Work light
5. What voltage do you require?
6. Do you have a single concrete block at least 4" thick for the machine base?
7. Is the door big enough to get the machine into the shop?
8. What upper punches do you require? (Standard, gooseneck, acute)
9. Do you require a separate female die for each thickness of material?
10. Would a 4-way die and die holder with rollover bars be beneficial?
11. Do you need a die holder to hold dies or 4-way? (Note: machine is not furnished with a die holder-riser)
12. Is an adjustable tonnage control for fragile dies needed?

It's versatile, accurate, rugged, easy to operate and easy to maintain. That's the way Betenbender makes its Press Brakes.

Whether you bend plastic or steel, there's a Betenbender Hydraulic Press Brake to match your needs, ranging from the 20-ton model to the 1000-ton model. No matter the size, each machine features convenient operation for maximum output and ease of maintenance for maximum productivity.

Betenbender goes the extra mile to build a Press Brake that works hard, works accurately, and maintains its quality for years to come.

When your name goes on the finished product, so does your reputation. We feel the same way. Compare features. Compare results. You can count on first-class American technology, rugged durability, versatility and economy when your machine made by Betenbender Manufacturing, Inc.



50-70T

PRESS BRAKES

Proven Performance

Betenbender Press Brakes are engineered to handle your metal forming requirements and have proven their performance in thousands of field installations.

STANDARD FEATURES

- 2 Speed Ram (20T-70T)
- 3 Speed Ram (95T-1000T)
- All Hydraulic Fluids Included
- All Steel Construction
- American Made Hoses and Fittings
- American Made Valves and Motors
- Bottom Time Delay
- Clamp Type Backgauge- Manual Adjustable X, Y, & Z - 24"
- Cylinders are Steel, Double Acting Piston Type with Hardened, Ground and Chromed Rods
- Depth Stop with Digital Readout
- Disconnect Switch
- Front & Back of Bed Machined Smooth for Mounting of Gauges
- Hardened Pins with Spherical Bearings for Alignment
- Hour Meter
- Hydraulic Pressure: 2500 psi
- NEMA Electrics
- Three Position Foot Switch by Linemaster

Multi-Switch Control Panel (with emergency switch, run-jog, and up/down buttons) and 3-position fully guarded foot switch by Linemaster

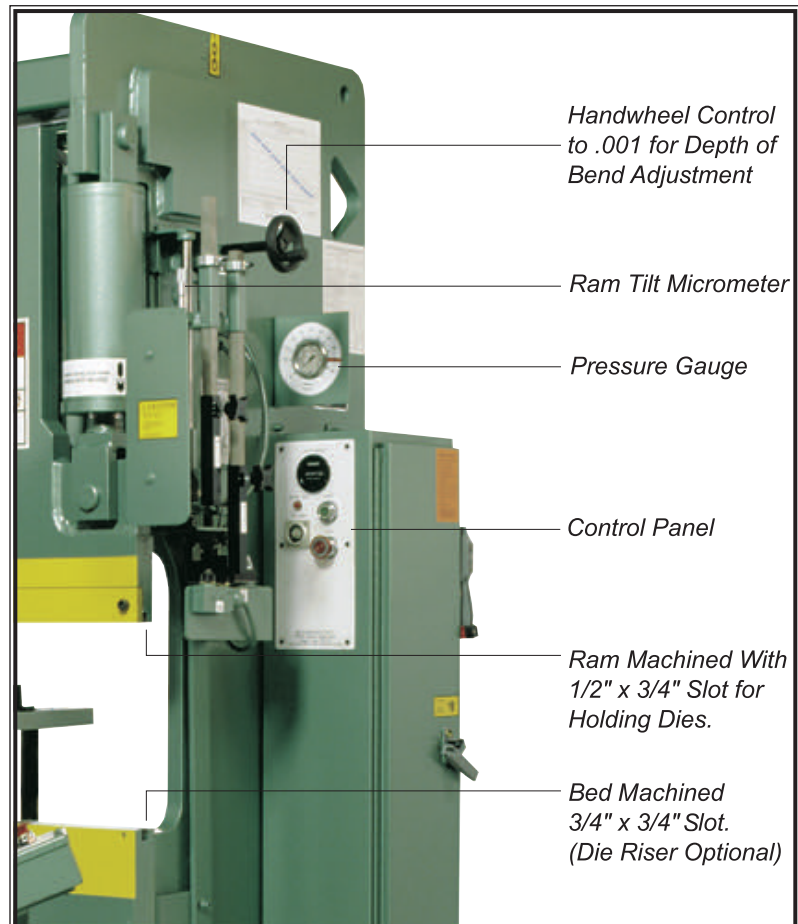

PRESS BRAKES

Like The Shear, You Can Take Betenbender's High Quality Press Brake & Add Options To "Build It Your Way!"

OPTIONS

Every shop is different. Your shop may need a Hydraulic Press Brake unique to your business.

We will work with you to build a unit to fit your job and your budget.

Building a Betenbender Press Brake with the options you need is the best way to get the most from your equipment in performance and results. Betenbender Manufacturing, Inc. offers you a quality machine in design, construction and durability.



*Operator Station
Palm Control with
3-position Fully
Guarded Foot
Switch by
Linemaster*



Tooling for Punching Applications



*The Optional Front
Reading Manual
Backgauge Features
an Attached Meter,
Clearly Indicating
Where the Gauge Bar
is Located in Relation
to the Die.*



*24" Front
Support Arm
"Slide" Type with
Disappearing Stop*



24" Front Support Arm "Slide" Type

PRESS BRAKES

OPTIONS

- 24" Support Arms "Slide" Type
- Keylock Switch
- Light Curtain
- Manual Front Reading Backgauge (24") with Mechanical Readout
- One Shot Lubrication
- Operator Station Palm Control
- Variable Tonnage Control
- Work Light
- 208v Single Phase
- Additional Foot Pedal with Keylock
- Air Lift (Recommended for 4/Way Dies)
- Angle Brackets (Plates) for Bottom
- Angle Brackets (Plates) for Top
- Automatic Lubrication
- Bed Machining Angle Brackets
- Bolt/Shim Kit for Leveling
- CNC Backgauge
- CNC Ram Stop
- Die Holder/Riser
- Die Rollover Bars (Recommended for 4/Way Dies)
- Disappearing Stops
- Dove Tails
- Dual Calibration
- Extended Support Arms (each)
- Extra Length on Backgauge
- Increase Stroke Length
- Increase Throat Gap or Increase Open Height
- Micrometer Precision Gauge Unit (2 Required)
- Oil Cooler
- Palm Buttons/Foot Control System (Hand buttons to preset height, stop and hold, foot to continue to shut height)
- Power Front Reading Backgauge with 5 Station NC "GO-TO" Positioner on Pendant
- Power Ram Adjustment with 5 Station NC "GO-TO" Positioner on Pendant
- Ram Machining
- Special Application Tooling
- Special Paint Colors
- T-Slots



Power Front Reading Backgauge and Power Ram Adjustment w/ 5 Station NC "GO-TO" Positioner on Pendant

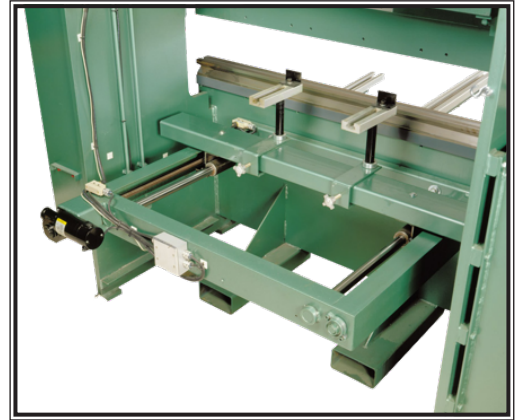

Power Front Reading Backgauge

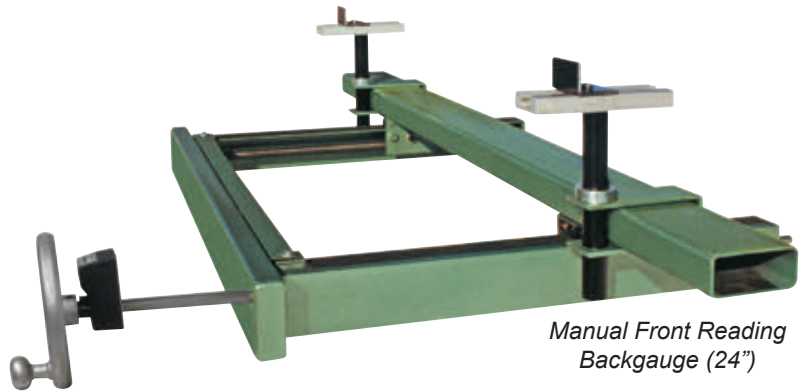

Manual Front Reading Backgauge (24")

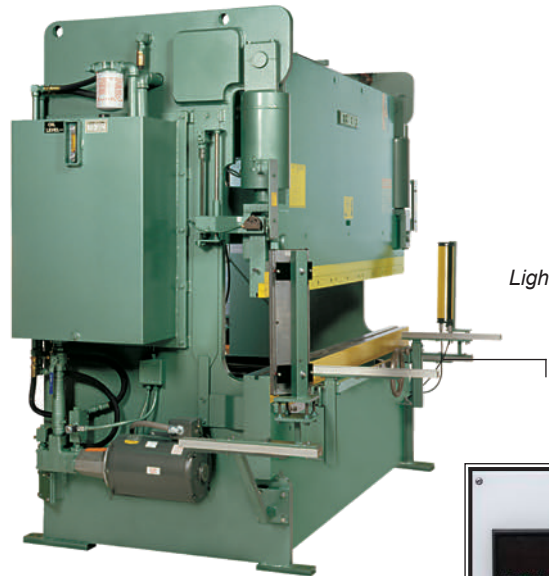

Light Curtain



99 Station Auto Sequence

ASK ABOUT OPTIONS NOT LISTED
RECOMMENDED OPTIONS

PRESS BRAKES

Our Standard & Optional Features Make Delivering Quality Easier

Simple & Flexible Controls: Our machines use either a convenient multi-switch control panel or a 3-position fully guarded foot switch.

Accuracy: Every Betenbender machine is thoroughly inspected and tested. Parallelism is maintained between bed and ram, or at a preset angle, by using precise automatic leveling controls. Parallelism is maintained at ± 0.002 inch in low speed.

The ram bottom reversal point is controlled by precise limit switches referenced off the bed. This isolates housing deflections which can interfere with accuracy.

The side situated handwheel sets the bottom limit of the ram stroke. Micrometer adjustment on the control end allows for tilting or paralleling of the ram. A bed referenced control monitors the actual distance between ram and bed, assuring repeatability independent of die wear or end plate deflection.

Versatility: Betenbender's Press Brakes have long, full tonnage stroke; adjustable length and selectable speed combinations; and adjustable height for short stroke. Two-speed is standard; three-speed with infinitely adjustable low speed is optional. This option prevents sudden whip up of the work during bending operations.

Maintenance: Clevis mounted cylinders eliminate cylinder binding, reducing the possibility of oil leaks. Pins and bushings do not rotate under load, resulting in much less wear than competitive products.

Easy Hydraulic System Maintenance: The manifold assembly saves space and makes it easy to replace many components. The convenient work height makes the job easier.

Convenient Settings: The readout displays in increments of 0.001 inch allows recorded settings of closed heights.

Standard Components: The control system components, micro switches, clamp-type backgauge, hydraulic fluid and filter cartridges are all standard equipment, making routine maintenance easier.

Flexibility: 2-speed ram is electrically controlled, and lets you shift to a lower speed before coming into contact with sheet metal.

Control: The ram stops at the point of reference and self-levels on every stroke. Main control cabinet enclosures are mounted on the side frame containing a magnetic, non-reversing motor, starter and 110/120v control circuit.

Safety and Reliability: The control system operates at 110/120v, using a minimum of circuitry. The system operates predominantly with American made electronics and American made motors.

Durability: The end frames, ram and bed are constructed of steel.

Electrical Equipment: Our machines meet the requirements of NFPA 79. They include drip proof, continuous duty 45°C ambient hydraulic pump motor wired for 208-230/460v 3 phase, 60 hertz, and other options are available. Our machines also meets the ANSI B11.3 standards.

Ram Level: Two hydraulic systems, one for each cylinder, keeps the ram parallel. The ram self-levels at the bottom of each stroke even if the hydraulic system is out of adjustment.



95-550T



BENDING PROPERTIES OF DIFFERENT STEELS TONNAGE CHARTS

Pressure In Tons Per Linear Foot
Required to Make 90 Degree Air Bend in Mild Steel
Tensile 58 ksi Yield 32 ksi

Tons Per Linear Foot		WIDTH OF FEMALE DIE OPENING																	
THICKNESS OF METAL		1/4	5/16	3/8	1/2	5/8	3/4	7/8	1	1 1/8	1 1/4	1 1/2	2	2 1/2	3	3 1/2	4	5	6
Gauge	Inches	Add 25% for A36 steel. This can vary with tensile and yield																	
20	.036	2.9	2.2	1.7	1.2	1.0													
18	.048		4.0	2.9	2.2	1.6	1.3												
16	.060			5.6	3.6	2.7	2.2	1.7											
14	.075				6.0	4.5	3.4	3.0	2.5	2.1									
13	.090					6.8	5.4	4.3	3.7	3.3	2.9								
12	.105					10.1	7.4	6.3	5.4	4.4	4.0	3.2							
11	.120						10.5	8.8	7.2	6.2	5.4	4.3	3.2						
10	.135							11.3	9.6	8.4	7.0	5.6	4.1						
9	.150								13.1	11.9	9.0	6.7	5.2	3.5					
7	.188									16.4	14.0	11.2	7.6	5.8	4.5				
1/4	.250										28.8	22.0	15.3	11.5	9.1	7.5	6.2		
5/16	.312											38.0	26.0	19.2	16.0	12.5	10.6	7.6	
3/8	.375												41.0	29.9	24.0	19.4	16.0	12.3	9.3
7/16	.437													45.2	35.0	28.0	24.0	17.0	14.6
1/2	.500														47.9	39.0	33.1	24.0	19.0

NOTE
We recommend using 85° or 88° dies
And or punches for air bending

Pressures shaded are for dies with female openings approximately 8x metal thickness, with radius on male die equal to metal thickness, and considered ideal for right angle bending

Pressure Required For Air Bending High-Tensile Low-Yield Steel

Tons Per Linear Foot		Tensile 80-90 ksi								Yield 30-40 ksi		
THICKNESS INCHES		WIDTH OF V-DIE OPENING (INCHES)										
		2	2 1/2	3	3 1/2	4	5	6	7	8	10	12
1/4	0.250	18.5	13.7	10.8	8.9	7.3						
5/16	0.313	32.4	23.9	18.4	15.2	12.6	9.2					
3/8	0.375	50.8	37	29	23.5	19.5	14.8	11.4				
7/16	0.438		55	42.5	30.5	29.5	21	17.5	13.5			
1/2	0.500			59	47.5	40	29.5	23.5	19	15.5		
5/8	0.625				84	70	51.5	40	33	28	20	
3/4	0.750					112	83	64	52	43	33	25
7/8	0.875						125	97	77	64	48	38
1	1.000							136	110	92	68	53

V-opening is 8x material thickness.

Punch radius equal to material thickness

Pressure Required For Air Bending High-Tensile Low-Yield Steel

V-opening is 10x material thickness.
Punch radius is 1 1/2x material thickness.

Tons Per Linear Foot		Tensile 60-75 ksi								Yield 45-55 ksi		
THICKNESS INCHES		WIDTH OF V-DIE OPENING (INCHES)										
		2	2 1/2	3	3 1/2	4	5	6	7	8	10	12
1/4	0.250	26	19.5	15.5	12.5	10.5						
5/16	0.313	46	33.5	26	21.5	18	13					
3/8	0.375			41	33.5	28	21	16				
7/16	0.438				48.5	41.5	29.5	23	19			
1/2	0.500					57	42	33	27	22		
5/8	0.625						74	57	47	40	29	
3/4	0.750							91	74	62	46	36
7/8	0.875								110	90	68	54
1	1.000								155	129	96	75

Plates Typical Properties

Properties shown for annealed and as rolled alloy plate are based on single test results.
They will vary considerably dependent on thickness.

Condition of Steel	Tensile Strength KSI	Yield Strength KSI	% Elong. In 2"	% Elong. In 8"	Approx. Brinell Hardness	
GENERAL PURPOSE						
1015	As Rolled	50	29	---	---	133
1020 Mild Steel	As Rolled	58	32	---	---	143
1025	As Rolled	70	34	---	---	156
ASTM A36, ASME SA36	As Rolled	58-80	36 min.	23	20	137

Bending Pressures Required For Other Metals As Compared To 60,000 P.S.I. Tensile Mild Steel On Chart:

Soft Brass.....50% of pressure listed
Soft Aluminum.....50% of pressure listed
Aluminum Alloys(Heat Treated).....same as steel
Stainless Steel.....50% more than steel

MODEL	A	B	C	D	E	F	G	H	I	J	K	L	M	N	O	P	HP	Wt.**
4-17	54	2	1 3/4	72	7	14	6-10	29-33	54	30 1/2	2	50	0-66	66	92	Std.	5	2,500
4-50	45	2	1 3/4	96	8	14	6	28	63	30 1/2	2	36	0-66	66	92	Std.	10	5,800
6-50	45	2	1 3/4	96	8	14	6	28	87	54 1/2	2	36	0-66	66	92	Std.	10	6,800
8-50	45	2	1 3/4	96	8	14	6	28	111	78 1/2	2	36	0-66	66	92	Std.	10	8,000
10-50	45	4	1 3/4	96	8	14	6	28	135	102 1/2	2	36	0-66	66	92	Std.	10	11,000
12-50	45	4	1 3/4	96	8	14	6	28	159	126 1/2	2	36	0-66	66	92	Std.	10	12,500
4-70	45	4	1 3/4	96	8	14	6	28	63	30 1/2	2	36	0-44	44	63	Std.	10	7,500
6-70	45	4	1 3/4	96	8	14	6	28	87	54 1/2	2	36	0-44	44	63	Std.	10	8,000
8-70	45	4	1 3/4	96	8	14	6	28	111	78 1/2	2	36	0-44	44	63	Std.	10	11,000
10-70	45	4	1 3/4	96	8	14	6	28	135	102 1/2	2	36	0-44	44	63	Std.	10	13,000
12-70	45	4	1 3/4	96	8	14	6	28	159	126 1/2	2	36	0-44	44	63	Std.	10	14,500
14-70	45	4	1 3/4	96	8	14	6	28	183	150 1/2	2	36	0-44	44	63	Std.	10	15,500
6-95	56 1/2	4	2 3/4	103	8	14	6	37	100	54 1/2	2 1/2	50	50	114	168	Std.	20	13,000
8-95	56 1/2	4	2 3/4	103	8	14	6	37	123	78 1/2	2 1/2	50	50	114	168	Std.	20	18,000
10-95	56 1/2	4	2 3/4	103	8	14	6	37	135	102 1/2	2 1/2	50	50	114	168	Std.	20	20,100
12-95	56 1/2	4	2 3/4	103	8	14	6	37	159	126 1/2	2 1/2	50	50	114	168	Std.	20	21,000
14-95	56 1/2	4	2 3/4	103	8	14	6	37	183	150 1/2	2 1/2	50	50	114	168	Std.	20	23,000
16-95	56 1/2	4	2 3/4	103	8	14	6	37	207	174 1/2	2 1/2	50	50	114	168	Std.	20	24,000
6-120	56 1/2	5	2 3/4	103	8	14	6	37	100	54 1/2	3	50	40	87	115	Std.	20	17,000
8-120	56 1/2	5	2 3/4	103	8	14	6	37	123	78 1/2	3	50	40	87	115	Std.	20	19,000
10-120	56 1/2	5	2 3/4	103	8	14	6	37	135	102 1/2	3	50	40	87	115	Std.	20	22,000
12-120	56 1/2	5	2 3/4	103	8	14	6	37	159	126 1/2	3	50	40	87	115	Std.	20	24,000
14-120	56 1/2	5	2 3/4	103	8	14	6	37	183	150 1/2	3	50	40	87	115	Std.	20	26,000
16-120	56 1/2	5	2 3/4	103	8	14	6	37	207	174 1/2	3	50	40	87	115	Std.	20	28,000
6-160	56 1/2	5	2 3/4	103	8	14	6	37	100	54 1/2	3	50	31	68	86	Std.	20	17,000
8-160	56 1/2	5	2 3/4	103	8	14	6	37	123	78 1/2	3	50	31	68	86	Std.	20	19,000
10-160	56 1/2	5	2 3/4	103	8	14	6	37	135	102 1/2	3	50	31	68	86	Std.	20	22,000
12-160	56 1/2	5	2 3/4	103	8	14	6	37	159	126 1/2	3	50	31	68	86	Std.	20	24,000
14-160	56 1/2	5	2 3/4	103	8	14	6	37	183	150 1/2	3	50	31	68	86	Std.	20	26,000
6-190	56 1/2	5	2 3/4	103	8	14	6	37	100	54 1/2	3	50	25	55	66	Std.	20	17,000
8-190	56 1/2	5	2 3/4	103	8	14	6	37	123	78 1/2	3	50	25	55	66	Std.	20	19,000
10-190	56 1/2	5	2 3/4	103	8	14	6	37	135	102 1/2	3	50	25	55	66	Std.	20	22,000
12-190	56 1/2	5	2 3/4	103	8	14	6	37	159	126 1/2	3	50	25	55	66	Std.	20	25,000
14-190	56 1/2	5	2 3/4	103	8	14	6	37	183	150 1/2	3	50	25	55	66	Std.	20	27,000
6-240	56 1/2	5 1/2	3 3/4	111	8	16	10	37	100	54 1/2	4	60	25	50	70	Std.	30	23,000
8-240	56 1/2	5 1/2	3 3/4	111	8	16	10	37	123	78 1/2	4	60	25	50	70	Std.	30	26,000
10-240	56 1/2	5 1/2	3 3/4	111	8	16	10	37	135	102 1/2	4	60	25	50	70	Std.	30	29,000
12-240	56 1/2	5 1/2	3 3/4	111	8	16	10	37	159	126 1/2	4	60	25	50	70	Std.	30	33,000
14-240	56 1/2	5 1/2	3 3/4	111	8	16	10	37	183	150 1/2	4	60	25	50	70	Std.	30	35,000
6-300	56 1/2	5 1/2	3 3/4	116	8	16	10	37	100	54 1/2	4	60	25	50	70	Std.	30	29,000
8-300	56 1/2	5 1/2	3 3/4	116	8	16	10	37	123	78 1/2	4	60	25	50	70	Std.	30	31,000
10-300	56 1/2	5 1/2	3 3/4	116	8	16	10	37	135	102 1/2	4	60	25	50	70	Std.	30	34,000
12-300	56 1/2	5 1/2	3 3/4	116	8	16	10	37	159	126 1/2	4	60	25	50	70	Std.	30	37,000
14-300	56 1/2	5 1/2	3 3/4	116	8	16	10	37	183	150 1/2	4	60	25	50	70	Std.	30	38,000
10-350	56 1/2	5 1/2	3 3/4	119	8	16	10	37	135	102 1/2	4	60	25	50	70	Std.	30	35,000
12-350	56 1/2	5 1/2	3 3/4	119	8	16	10	37	159	126 1/2	4	60	25	50	70	Std.	30	37,000
14-350	56 1/2	5 1/2	3 3/4	119	8	16	10	37	183	150 1/2	4	60	25	50	70	Std.	30	39,000

PRESS BRAKES

TECHNICAL SPECIFICATIONS

Frame: The frame is of open throat design with mounting holes in feet. Drilled and tapped holes in feet allow for leveling of the machine.

Bed: The machined flat surface is slotted full length to accommodate standard die holders, filter blocks, misc.

Front & Back of Bed: The bed is machined down 4" on the front and 12" on the back to allow a flat surface for mounting various brackets, supports and gauges.

Ram: The ram is constructed of solid steel slotted to accept standard dies. The clamping bar is sectional for positive clamping. The upper is machined up to 4" to allow a flat surface for mounting brackets and gauges.

Ram Tilt Adjustment: The micrometer spindle is located on the right side end frame of machine, which allows for adjustment of the desired angle required up to ± 0.500 inch. The micrometer allows the operator to return to a given setting, parallel to desired angle. By using the micrometer reading, the machine can return to previous position.

Ram Level: The ram level is accomplished by two hydraulic systems, one for each cylinder, which keeps them parallel. The ram self-levels at the bottom of each stroke even if hydraulic system is out of adjustment.

Hydraulic Cylinders: Direct acting hydraulic cylinders are one piece, double acting with self-aligning, hardened ball sockets.

Accuracy: Parallelism is maintained at ± 0.002 inch in low speed.

Operating Controls:

1. Pull to start. Push off. Light is on when in the "ON" position.
2. Run/Jog switch. Run position for normal operation. Jog position for loading of tooling, maintenance and set-up. Up/Down buttons are used when in jog.
3. 3 Position Foot Petal
 - a. Ram up
 - b. Ram hold
 - c. Foot petal down. Ram down allows or jogging of ram down and holding. Emergency stop and emergency up buttons are located on a small pedestal that comes from the foot petal.
4. Cycle time delay at bottom of stroke

When using top & bottom tools on a press brake, a forming system is created which requires analysis to determine the appropriate safeguarding for operator safety and protection.

It is the user's responsibility to ensure that the point of operation is effective and all applicable safety requirements are met.



Stroke Control (Optional): Control of strokes in accomplished by rotation of hand wheels, which read in thousandths of an inch and set the closed height. When the machine is 2 or 3 speed, the knob for setting the speed change point is located on right side for simple adjustments.

Tonnage Control (Optional): Our machines are equipped with optional adjustable tonnage control to go from lower tonnage to rated tonnage of machine, as well as overload protection.

Backgauge: A slide and clamp, 3 axis backgauge 24" is standard.

1. Front operated manual backgauge, hand wheel with mechanical readout (0.01)
2. Front operated power backgauge with LED readout (0.001)

CNC backgauging and front gauging is optional.

Front Support Arms (Optional): 24" support arms are "slide" type. Optional disappearing stops help to hold the material from sliding backward.

Electrical System: The electrical systems meet NFPA 79 standards. All machines have disconnect switches, magnetic starters, 110/120v controls, 208-230/460v 3 phase, others optional.

Motors: Our American made motors are rated for continuous duty, open drip.

Lubrication: Grease zerks are standard. One shot lube or automatic lubrication is optional.

Safety Features: Betenbender Hydraulic Press Brakes and Shears are built to meet ANSI B11.3 standards. Safety features of the Betenbender Press Brake include:

- Emergency stop on pedestal
- Emergency up on pedestal
- Warning signs, safety markings and covers
- Electronics meet NFPA 79 standards
- 110/120v control

Specifications are subject to change without notice.

Compliance with OSHA requirements is the legal responsibility of the user and is subject to local inspectors' interpretation of existing standards.

Betenbender Shears are built to meet ANSI B11.3 standards

Convert Feet to Millimeters Multiply By 304.8	
2'	609.6 mm
4'	1219.8 mm
5'	1524.0 mm
6'	1828.8 mm
8'	2438.4 mm
10'	3048.2 mm
12'	3657.6 mm
14'	4267.2 mm

Convert Inches to Millimeters Multiply By 25.4		
1/8"	0.125	3.18 mm
3/16"	0.188	4.77 mm
1/4"	0.250	6.35 mm
3/8"	0.375	9.53 mm
1/2"	0.500	12.7 mm
5/8"	0.625	15.88 mm
3/4"	0.750	19.05 mm
1"	1.000	25.4 mm



HMI offers the most versatile C-Frame press or punch of all machines available today. The extra large throat depth and height not found on many machines allows for an unlimited number of uses. The infinitely adjustable stroke from 0" to 8" makes it one of the most valuable and versatile assets for your shop you could have today. Let one machine do the work of several. HMI has designed their press frames to have fewer tons per square inch of pressure on their side plates, thus reducing spring back of the frame. This reduces tooling wear.

Features

- Large heavy duty design of the press frame to limit the deflection.
- Press bed bolted on, not welded, to prevent distortion. Can be easily removed for regrinding or adding more tapped holes.
- Large rectangular tubes used at base of machine to give safe, instant portability. Oil reservoir is located vertically between the side plates to keep the machine's footprint as small as possible.
- Hydraulic system is equipped with a wire mesh strainer on the suction side and a 10 micron filter on the return side to keep the system clean.
- Pump, motor, valve and reservoir are all easily accessible for maintenance.
- Large press bed to accommodate a variety of tooling other than just punching.
- Reservoir filled with oil.
- Lock out - tag out accommodations.
- Operators manual.



**APPROXIMATE TONNAGE REQUIRED
FOR PUNCHING ROUND HOLES IN MILD STEEL (50,000 psi shear strength)
Add 25% for A36 Steel**

Hole Dia. In Inches	20 GA. .036	18 GA. .048	16 GA. .060	14 GA. .075	12 GA. .105	11 GA. .120	10 GA. .135	3/16 .187	1/4 .250	5/16 .312	3/8 .375	1/2 .500
1/8	.35	.47	.59	.74	1.0	1.2	---	---	---	---	---	---
3/16	.53	.71	.89	1.1	1.6	1.8	2.0	2.8	---	---	---	---
1/4	.71	.94	1.2	1.5	2.1	2.4	2.7	3.7	4.9	---	---	---
5/16	.88	1.2	1.5	1.9	2.6	3.0	3.3	4.6	6.2	7.8	---	---
3/8	1.1	1.4	1.8	2.2	3.1	3.5	4.0	5.5	7.4	9.2	11.1	---
7/16	1.2	1.7	2.1	2.6	3.6	4.1	4.6	6.5	8.6	10.8	13.0	17.2
1/2	1.4	1.9	2.4	2.9	4.1	4.7	5.3	7.4	9.8	12.3	14.8	19.7
9/16	1.6	2.1	2.7	3.3	4.7	5.3	6.0	8.3	11.0	13.8	16.6	22.1
5/8	1.8	2.4	2.9	3.7	5.2	5.9	6.6	9.2	12.3	15.4	18.5	24.6
11/16	1.9	2.6	3.2	4.1	5.7	6.5	7.3	10.2	13.5	16.9	20.3	27.1
3/4	2.1	2.8	3.5	4.4	6.2	7.1	8.0	11.1	14.8	18.4	22.1	29.5
13/16	2.3	3.1	3.8	4.8	6.7	7.7	8.6	12.0	16.0	20.0	24.0	32.0
7/8	2.5	3.3	4.1	5.2	7.2	8.3	9.3	12.9	17.2	21.5	25.8	34.4
15/16	2.7	3.5	4.4	5.5	7.7	8.8	10.0	13.8	18.5	23.0	27.7	36.9
1	2.8	3.8	4.7	5.9	8.3	9.4	10.6	14.8	19.7	24.6	29.5	39.4
1 ½	4.2	5.6	7.0	8.8	12.3	14.1	15.8	22.1	29.5	36.8	44.2	58.9
2	5.6	7.5	9.4	11.7	16.4	18.8	21.1	29.5	39.3	49.1	58.9	78.5
2 ½	7.1	9.4	11.7	14.7	20.5	23.6	26.4	36.8	49.1	61.4	73.6	98.2
3	8.5	11.3	14.1	17.6	24.6	28.2	31.7	44.2	58.9	73.6	88.4	118
3 ½	9.9	13.1	16.4	20.5	28.8	32.7	37.0	51.5	68.7	85.9	103	137
4	11.3	15.0	18.8	23.5	32.8	37.6	42.2	58.9	78.5	98.2	118	157
4 ½	12.7	16.9	21.2	26.4	37.0	42.4	47.5	66.3	88.4	110	133	177
5	14.1	18.7	23.5	29.3	41.1	47.1	52.8	73.6	98.2	123	147	196

**To obtain tonnage required for punching round holes in mild steel multiply as follows:
3.1416 x Diameter of Hole x Material Thickness x 25 = Punching Tonnage Required for One Hole**

This line of hydraulic machines offers the best value in any line of punching equipment today! With a wide range of tonnages, throat heights, throat depths and stroke length, there is a machine to fit your needs!

STANDARD FEATURES

- 2 Hand Controls
- Bolt on Table
- Auto Return to Top of Stroke
- All Hydraulic Fluids
- NEMA Electrics
- Disconnect Switch
- All Steel Construction

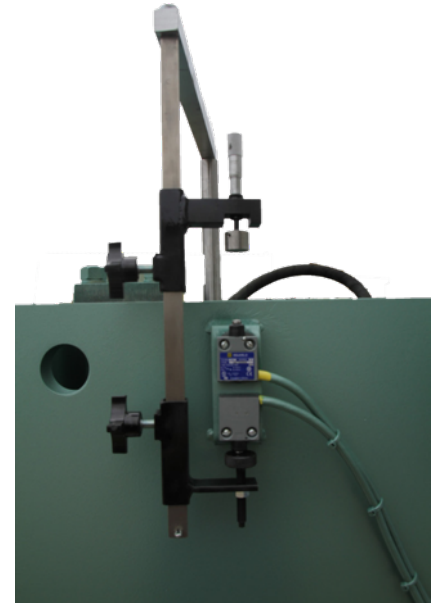

OPTIONS

- Punch Kit: Includes Punch Stem, Coupler Nut, Die Holder & Wrench
- Ram Adapter
- Hairpin Guarding
- Foot Switch with Keyed Foot / 2 Hand / Jog Selector Switch
- Special Open Heights, Throat Depths & Stroke Lengths Available



HMI SPECIFICATIONS

A	Throat Depth	D	Bore
B	Throat Height	E	Tonnage @ 2500 PSI
C	Stroke Length	F	Hydraulics (GPM)

MODEL	A	B	C	D	E	F	HP	Wt.**
3514	14	18	8	6	35	9	10	4,800
5014	14	18	8	7	48	9	10	5,900
6014	14	18	8	8	62	11	15	8,100
8014	14	18	8	9	79	11	15	9,300
10014	14	18	8	10	98	18	20	11,500
12014	14	18	8	11	118	18	20	13,750
14014	14	18	8	12	141	18	20	16,000
16514	14	18	8	13	165	18	20	19,000

Please Note:
ALL measurements
and weights may
vary from the
figures given in
this Specification
Chart.



All dimensions are in inches unless otherwise noted.
 (To convert to centimeters multiply by 2.54)

Engineering data and dimensions are subject to change without notice due to continuing product development.



Foundation plans are available upon request.

**ESTIMATED WEIGHTS. The weight of your machine may vary from the estimated weight listed here. Weights may vary according to options included.

HP	AMPS	
	208/230	460
10	28	14
15	39.6	19.3
20	52	26

THANK YOU

Serial Numbers & Oil Information

Model No.	Serial No.
BETENBENDER MANUFACTURING, INC.	
	<p>5806 Quality Ridge Rd PO Box 140 Coggon, IA 52218 319-435-2378 www.betenbender.com</p> 
WE RECOMMEND THE FOLLOWING LUBRICANTS:	
<p>Hydraulic Oil.....Mobil DTE 25 Grease Points.....Lubriplate 930-AA</p>	
<i>AMERICAN MADE WITH PRIDE AND DURABILITY SINCE 1972</i>	
For Mobil product information, please call 1-800-662-4525	



American Pride and Trusted

SERVICE

An International System



No matter where you are, there is a Betenbender Manufacturing, Inc. representative available.

Our full line of American-Made Hydraulic Shears, Press Brakes, and C Frame Presses are represented by statewide dealers and serviced by regional distribution and service offices.

International dealers -- we ship and market worldwide.

Call to find out who your personal representative is -- **319-435-2378**

Or email -- **sales@betenbender.com**

Or visit our website -- **www.betenbender.com**

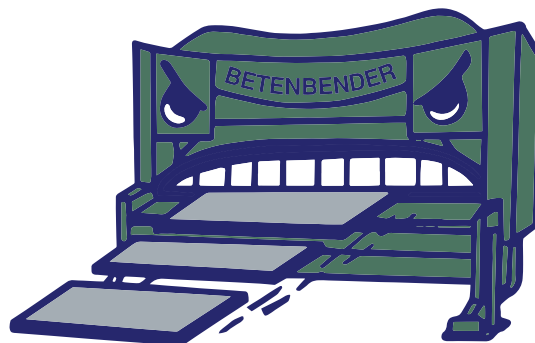

All machines are made in the heartland of the USA in Coggon, Iowa

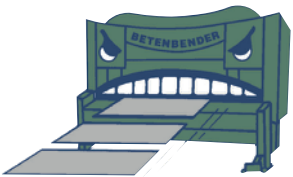

BETENBENDER MANUFACTURING, INC.

5806 Quality Ridge Road

P.O. Box 140

Coggon, Iowa 52218

Office: 319-435-2378

Fax: 319-435-2262

www.betenbender.com

sales@betenbender.com